

# HP 7035B

## X-Y RECORDER

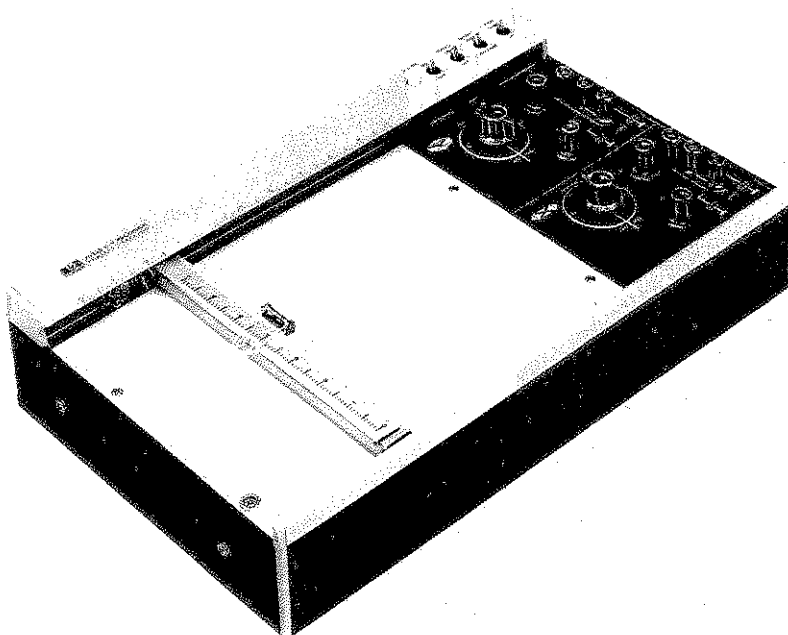

## OPERATING AND SERVICE MANUAL

# HP 7035B X-Y RECORDER

### SERIAL NUMBERS

This manual applies directly to HP Model 7035B X-Y Recorders with serial numbers prefixed 2007A.

With changes described in Section VIII, this manual also applies to recorders with serial numbers prefixed 1722A, 1620A, 1604A, 1543A, 1513A, 1447A, 1340A, 1320A, 1206A, 1114A, 1049A, 1040A, 1025A, 1017A, 926, 845, and below.

For additional important information about serial numbers, see MODEL — MANUAL INFORMATION in Section I.

©1981, 1983, 1984, 1985, 1986 by HEWLETT-PACKARD COMPANY  
16399 W. BERNARDO DRIVE, SAN DIEGO, CALIFORNIA 92127-1899

MANUAL PART NO. 07035-90005  
Microfiche Part No. 07035-90055

Printed: JANUARY 1986

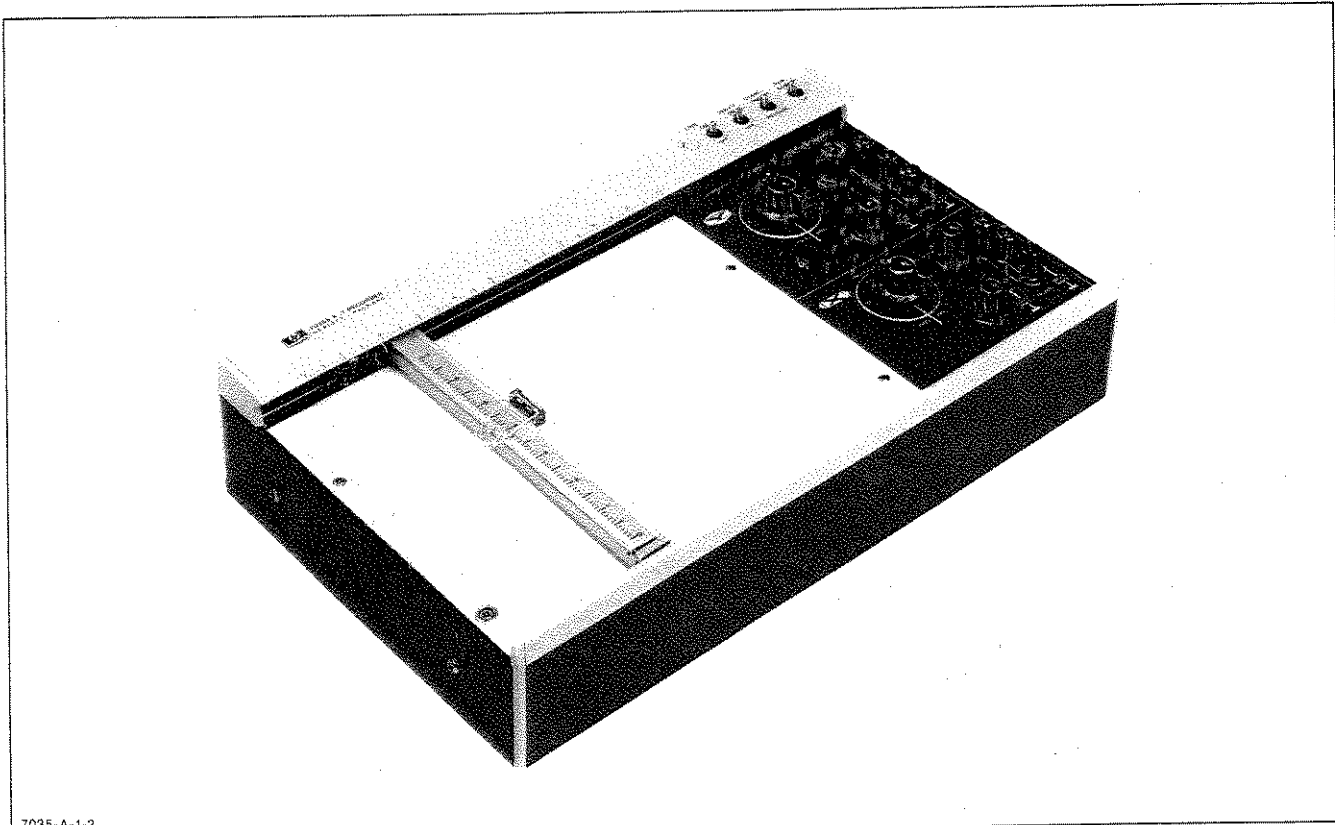

7035-A-1-2

Figure 1-1. Model 7035B X-Y Recorder

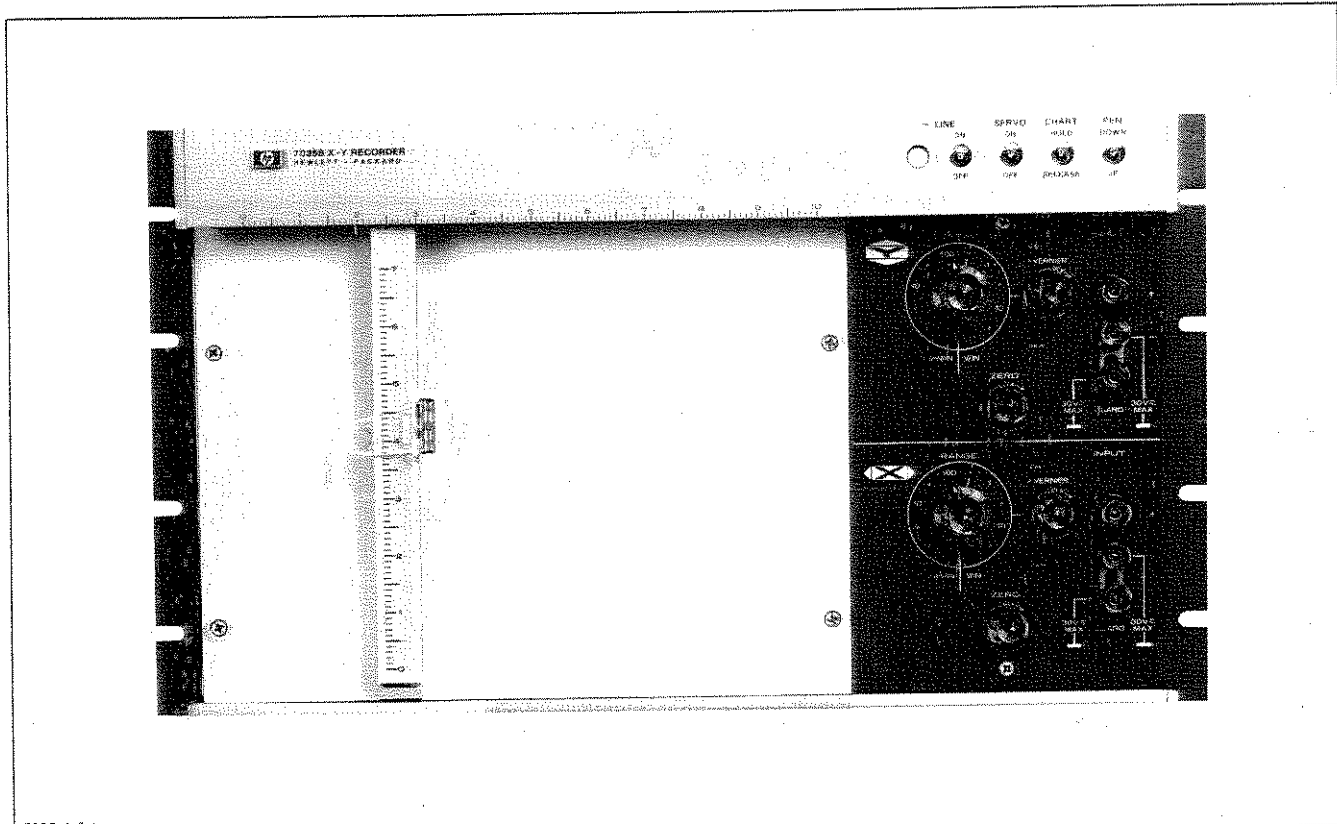

7035-A-3-1

Figure 1-2. Model 7035B X-Y Recorder — Option 908 (With Rack Mount Brackets)

# SECTION I

## INTRODUCTION

### 1-1. DESCRIPTION

#### 1-2. BASIC FRAME

1-3. The Hewlett-Packard Model 7035B X-Y Recorder is a general purpose laboratory instrument designed for plotting Cartesian coordinate graphs from dc electrical sources. Specially guarded and shielded circuitry provides one megohm input resistance at null on all fixed and variable ranges from 100 mV/in. (40 mV/cm) and above. Five calibrated dc input ranges in each axis, the most sensitive is used potentiometrically, are standard features. Arbitrary full scale voltage ranges may be used with calibrated dc ranges by using a variable input attenuator. The electrostatic paper holddown platen accepts standard  $8\frac{1}{2} \times 11$  inches or smaller graph paper. The recorder is readily adaptable from bench to rack mounting by installing rack mounting brackets, Option 908. See Figures 1-1 and 1-2 for general configuration.

#### 1-4. MODEL—MANUAL INFORMATION

1-5. This manual is applicable to the Model 7035B with a serial prefix of 2007A. The serial prefix is the first four digits and a letter of a two-part ten-item serial number (0000A-00000) used to identify each Hewlett-Packard instrument (see Figure 1-3). Should any change to this manual be necessary, a new serial prefix will be assigned to the changed model and a Manual Changes sheet will be supplied defining the differences between the changed model and the one described within this manual. Other corrections due to any errors that existed when this manual was printed will be provided. This type of change, called Errata, also appears on the Manual Changes sheet. For additional information pertaining to this Model 7035B, or other Hewlett-Packard instruments, contact the nearest Hewlett-Packard Sales/Service Office.

#### 1-6. SPECIFICATIONS

1-7. Table 1-1 lists the specifications for this recorder. Figure 1-4 illustrates the outside dimensions:

#### 1-8. OPTIONS

##### 1-9. METRIC CALIBRATION (OPTION 001)

1-10. Ordering this option will provide a metrically scaled and calibrated version of this recorder. (HP Service Center installation only.)

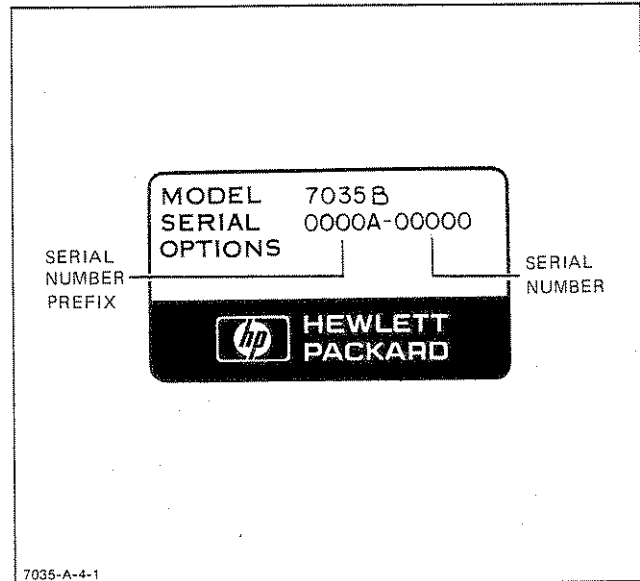

Figure 1-3. Instrument Identification

##### 1-11. X-AXIS RETRANSMITTING POTENTIOMETER (OPTION 003)

1-12. This option provides a potentiometer that is coupled to the X-axis drive system. The potentiometer is  $5\text{ k} \pm 3\%$  with  $\pm 0.1\%$  linearity, and 0.4% resolution. (HP Service Center installation only.)

##### 1-13. RACK MOUNTING BRACKETS (OPTION 908)

1-14. Rack mounting brackets (Option 908) are available and easily installed. Use of this option permits the recorder to be rack mounted.

##### 1-15. EXTRA MANUAL (OPTION 910)

1-16. Ordering this option will provide the user with one extra copy of the 7035B Operating and Service Manual.

#### 1-17. ACCESSORIES

1-18. Accessories supplied with each recorder are listed in Table 1-2, Accessories Supplied. Other accessories for special applications may be ordered. These accessories, which do not require recorder modification, are described in the following paragraphs and illustrated in Figure 1-5.

Table I-1. Model 7035B Specifications

PERFORMANCE		RANGE		DC (CMR)	AC (CMR)																						
		STANDARD	METRIC																								
<p>Input Range: 1, 10, 100 mV/in.; 1 and 10 V/in. (Option 001, Metric calibration: 0.4, 4, 40, 400 mV/cm and 4 V/cm). Continuous vernier between ranges.</p> <p>Type of Input: Floated and guarded signal pair. Input may be operated up to <math>\pm 30</math> Vac or dc with respect to chassis ground. Signal and guard terminals are available at the front panel or at the rear connector. Mating rear connector is supplied.</p> <p>Input Resistance:</p> <table border="1"> <thead> <tr> <th>RANGE</th> <th>INPUT RESISTANCE</th> </tr> </thead> <tbody> <tr> <td>1 mV/in. (0.4 mV/cm)</td> <td>Potentiometric (essentially infinite at null)</td> </tr> <tr> <td>Variable</td> <td>11 k</td> </tr> <tr> <td>10 mV/in. (4 mV/cm)</td> <td>100 k</td> </tr> <tr> <td>Variable</td> <td>100 k</td> </tr> <tr> <td>100 mV/in. (40 mV/cm)</td> <td>1 meg</td> </tr> <tr> <td>Variable</td> <td>1 meg</td> </tr> <tr> <td>1 V/in. (400 mV/cm)</td> <td>1 meg</td> </tr> <tr> <td>Variable</td> <td>1 meg</td> </tr> <tr> <td>100 V/in. (4 V/cm)</td> <td>1 meg</td> </tr> <tr> <td>Variable</td> <td>1 meg</td> </tr> </tbody> </table>		RANGE	INPUT RESISTANCE	1 mV/in. (0.4 mV/cm)	Potentiometric (essentially infinite at null)	Variable	11 k	10 mV/in. (4 mV/cm)	100 k	Variable	100 k	100 mV/in. (40 mV/cm)	1 meg	Variable	1 meg	1 V/in. (400 mV/cm)	1 meg	Variable	1 meg	100 V/in. (4 V/cm)	1 meg	Variable	1 meg	1 mV/in.	0.4 mV/cm	130 dB	100 dB
RANGE	INPUT RESISTANCE																										
1 mV/in. (0.4 mV/cm)	Potentiometric (essentially infinite at null)																										
Variable	11 k																										
10 mV/in. (4 mV/cm)	100 k																										
Variable	100 k																										
100 mV/in. (40 mV/cm)	1 meg																										
Variable	1 meg																										
1 V/in. (400 mV/cm)	1 meg																										
Variable	1 meg																										
100 V/in. (4 V/cm)	1 meg																										
Variable	1 meg																										
		10 mV/in.	4 mV/cm	110 dB	80 dB																						
		100 mV/in.	40 mV/cm	90 dB	60 dB																						
		1 V/in.	400 mV/cm	70 dB	40 dB																						
		10 V/in.	4 V/cm	50 dB	20 dB																						

RANGE	INPUT RESISTANCE
1 mV/in. (0.4 mV/cm)	Potentiometric (essentially infinite at null)
Variable	11 k
10 mV/in. (4 mV/cm)	100 k
Variable	100 k
100 mV/in. (40 mV/cm)	1 meg
Variable	1 meg
1 V/in. (400 mV/cm)	1 meg
Variable	1 meg
100 V/in. (4 V/cm)	1 meg
Variable	1 meg

Maximum Allowable Source Resistance: 20 k ohm on most sensitive range, 10 k ohm on other ranges.

Normal Mode Rejection (at line frequency):  $>30$  dB (18 dB/octave roll-off above 60 Hz).

Common Mode Rejection: Conditions for the following data are dc or line frequency ac with up to 1 k ohm between the positive and negative inputs, and the negative input connected to the guard terminal. Maximum allowable dc or dc plus peak ac common mode voltage is 30 Vac or dc.

Slewing Speed: 20 in./s, 50 cm/s, nominal at 115 V line; 18 in./s, 45 cm/s minimum.

Accuracy:  $\pm 0.2\%$  of full scale.

Linearity:  $\pm 0.1\%$  of full scale.

Resettability:  $\pm 0.1\%$  of full scale.

Reference Stability: Continuous electronic zener reference with temperature stability better than 0.002%/degree Celsius.

Zero Set: Zero may be placed anywhere on the writing area or electrically off scale up to one full scale from zero index. Adjustable by a locking ten-turn, high resolution control.

**GENERAL**

Writing Mechanism: Servo actuated ink pen.

Writing Area: 7 in.  $\times$  10 in. (18 cm  $\times$  25 cm).

Paper Holddown: Electrostatic paper holddown grips charts 8½ in.  $\times$  11 in. or smaller. Special paper is not required.

Pen Lift: Electric pen lift with provision for remote control.

Power: 115 or 230 Vac  $\pm 10\%$ , 48 to 66 Hz, approximately 45 W.

Weight: Net, 18 lb (8 kg); shipping, 24 lb (10.9 kg).

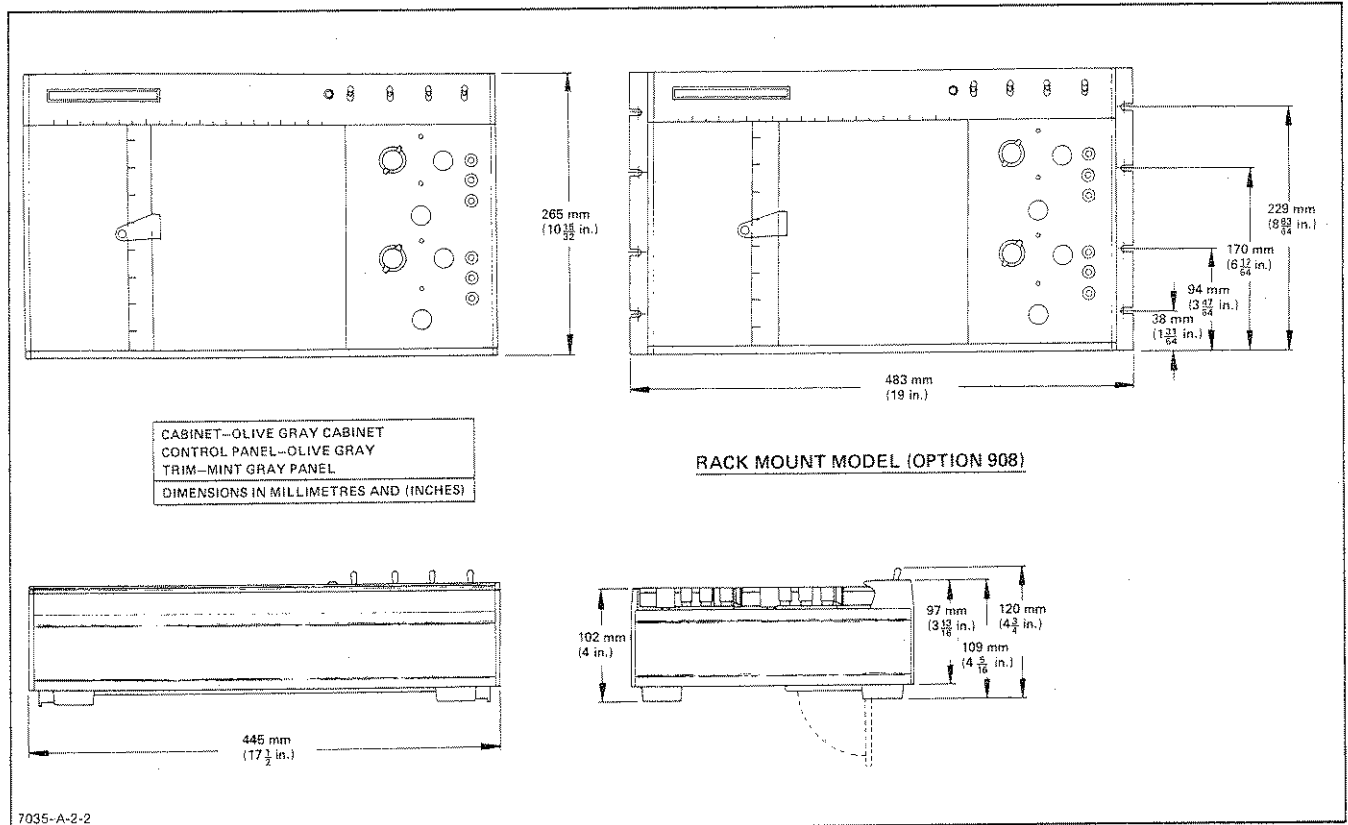

Figure 1-4. Dimension Drawing

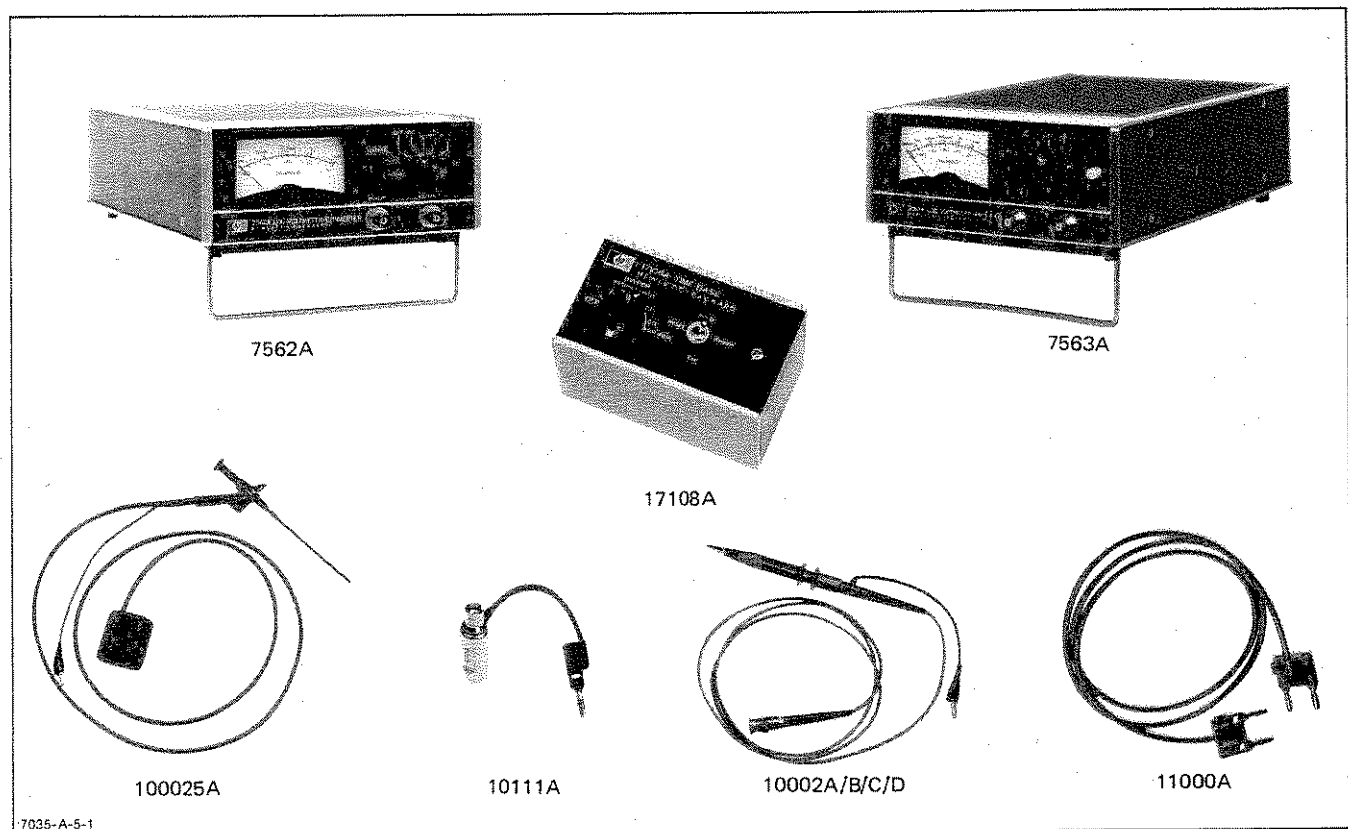

Figure 1-5. Accessories Available

1-19. MODEL 7562A LOGARITHMIC CONVERTER

1-20. The Model 7562A Logarithmic Converter produces dc output voltages in logarithmic relationship to other dc input voltages, or true amplitude RMS of ac input voltages, in a 10 000 to 1 (80 dB) amplitude range. The all solid-state, single-channel converter allows semi-log plotting with X-Y and strip chart recorders. An oscilloscope output is also provided for waveform monitoring. A broad frequency range records 100 kHz to 0.5 Hz. Two converters may be used for log-log recording, increasing its usefulness.

1-21. MODEL 7563A LOG VOLTMETER/AMPLIFIER

1-22. The Model 7563A DC Log Voltmeter/Amplifier is designed to perform two independent operations. As a voltmeter, usable over a 110 dB input amplitude range, accurate readings within 1.5 dB over an 80 dB dynamic range are achieved, and the need for range switching is unnecessary. As a log amplifier, output signals are logarithmically related to applied input signals; this solid-state amplifier permits semi-log plotting operations with HP X-Y and strip chart recorders, and will operate with most other recorders and oscilloscopes. Two amplifiers may be used for log-log records.

1-23. MODEL 17108A TIME BASE

1-24. The 17108A is a self-contained external time base which will operate on either axis of the 7035B. Any number of recorders may be driven simultaneously providing the combined parallel input impedance is 20,000 ohms or more. Five sweep speeds are provided from 0.5 to 50 seconds/inch.

1-25. MODEL 10025A STRAIGHT-THROUGH VOLTAGE PROBE

1-26. The 10025A is a flexible probe with small, push-button pincer jaws which provide a straight-through connection to the 7035B. Maximum input voltage is 600 volts peak. The cable is terminated in a shielded dual banana plug.

1-27. MODEL 10111A ADAPTER

1-28. The 10111A (shielded banana-post-to-female-BNC) converts banana post inputs on 7035B to shielded BNC inputs for low-level signal work. These adapters may be used in pairs for balanced input characteristics.

1-29. MODEL 10002A/B/C/D VOLTAGE DIVIDER PROBE

1-30. The Voltage Divider Probe (50:1) extends the voltage range of the 7035B to 1000 volts full scale. The accuracy  $\pm 3\%$ . The high input impedance (9 M $\Omega$ ) of this probe also reduces the loading of the 7035B on the system under test. The probe requires a 10111 Adapter, and is not usable on the 1 mV/in. and 10 mV/in. (0.4 mV/cm and 4 mV/cm) ranges. The length of the 10002A is 5 feet, 10002B is 10 feet, 10002C is 5 feet with a black identification boot, and the 10002D is 10 feet with a black identification boot.

1-31. MODEL 11000A CABLE ASSEMBLY

1-32. Dual banana plugs terminate a section of 50 ohm cable, 44 inches overall, plugs are for use with binding posts spaced  $\frac{3}{4}$  inch apart.

Table 1-2. Accessories Supplied

DESCRIPTION	HP PART NUMBER
ACCESSORY KIT, includes: Connector, Male, 24 Pin Slidewire Cleaner Slidewire Lubricant	07035-82660 1251-0293 5080-3605 5080-3635
GRAPH PAPER, HEAVY, 10 SHEETS English (Standard) or Metric (Option 001)	9270-1006 9270-1023
GRAPH PAPER, LIGHT, 10 SHEETS English (Standard) or Metric (Option 001)	9270-1007 9270-1027
FLEXIBLE DUST COVER	4040-0011
OPERATING AND SERVICE MANUAL	07035-90005
POWER CORD SET	(as ordered)

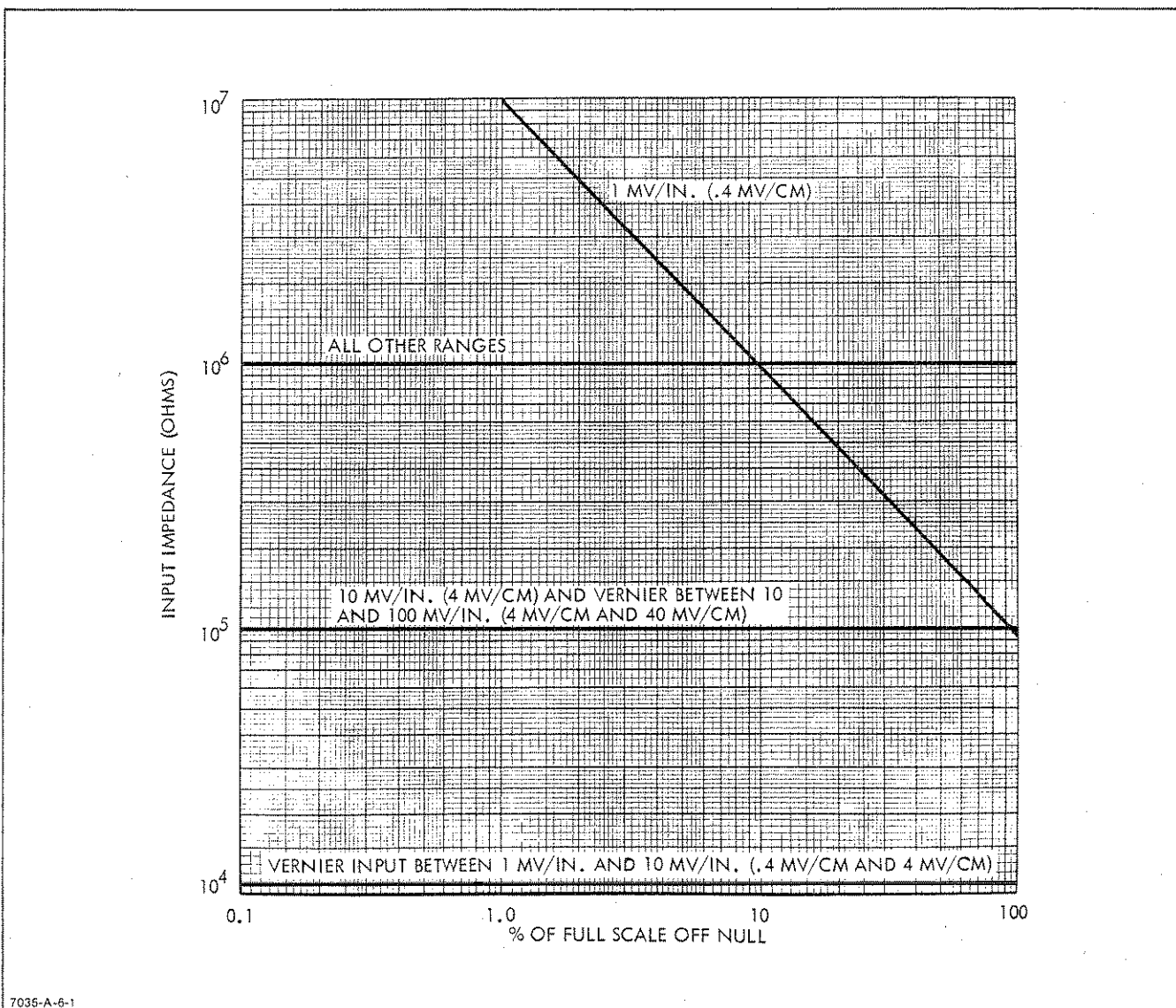

Figure 1-6. Input Resistance Characteristics

**1-33. TYPICAL PERFORMANCE**

**1-34. INPUT RESISTANCE VS OFF BALANCE CHARACTERISTICS**

1-35. The input resistance is constant, regardless of off balance condition except for the 1 mV/in. (0.4 mV/cm) range. This range, operating in potentiometric mode, draws all the current flowing in the balance loop through the input circuit. Referring to Figure 1-6, observe that a linear relationship exists between the distance off balance and the input resistance, and because the input resistance at 1% of full scale off balance is approximately 10 meg ohms, a small off balance condition is noticeable.

**1-36. NORMAL MODE NOISE**

1-37. This recorder is designed to record dc signals. Normal mode noise (line frequency) is often super-

imposed on the input signals, which if not eliminated, may produce unsatisfactory recordings. An excessive amount of noise can saturate the amplifier's output stage causing an increased dead zone and decreased pen speed. Pen oscillation may also result if the noise "beats" with the servo system's carrier frequency. A built-in low pass filter in both axes minimizes the effects of normal mode noise. The response of this filter is illustrated in Figure 1-7.

**1-38. DYNAMIC RESPONSE**

1-39. Figure 1-8 indicates the typical frequency response for a sinusoidal input. Although the recorder is designed to record slowly varying dc voltages, ac voltages up to a few Hz can be recorded.



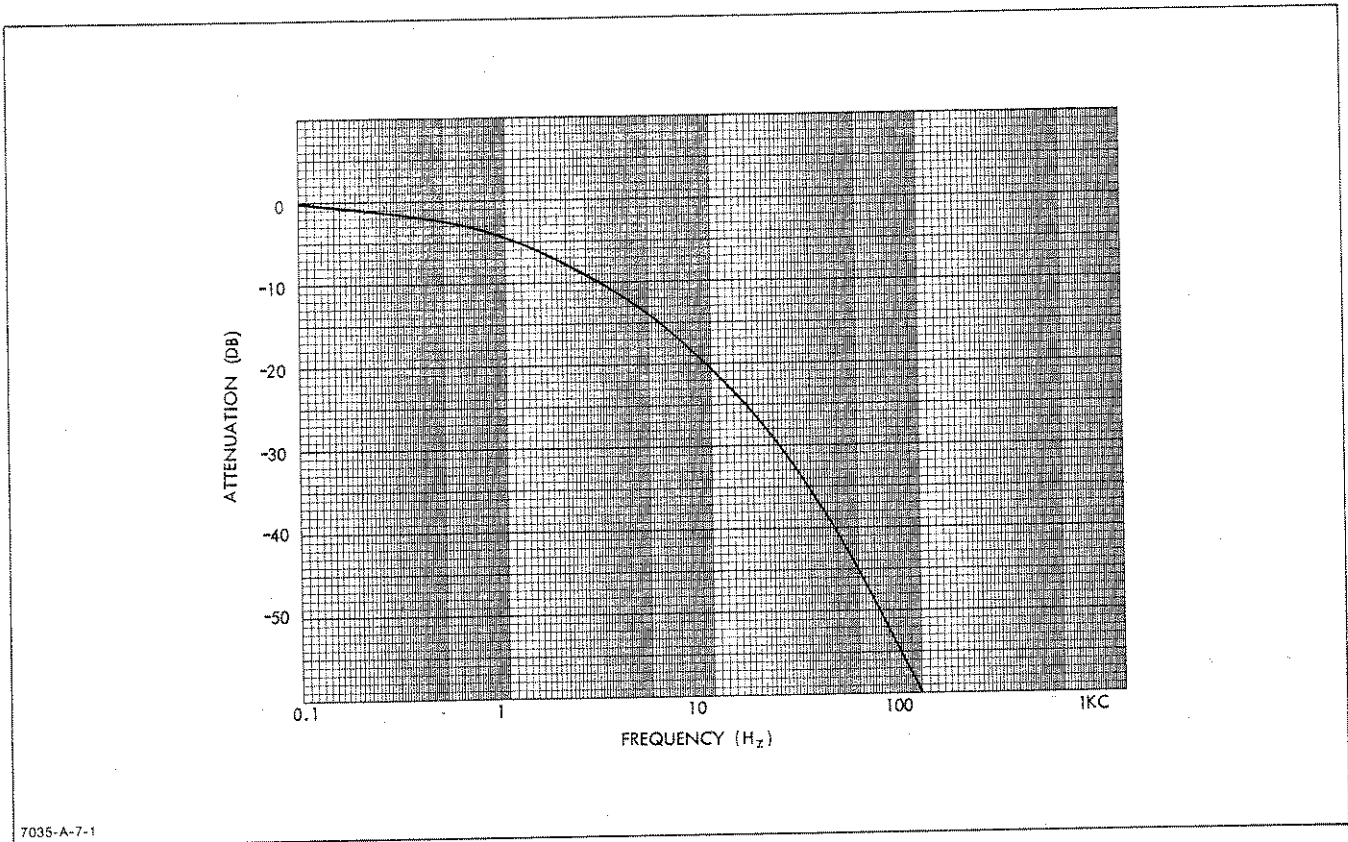

7035-A-7-1

Figure 1-7. Typical Frequency Response (Input Filter)

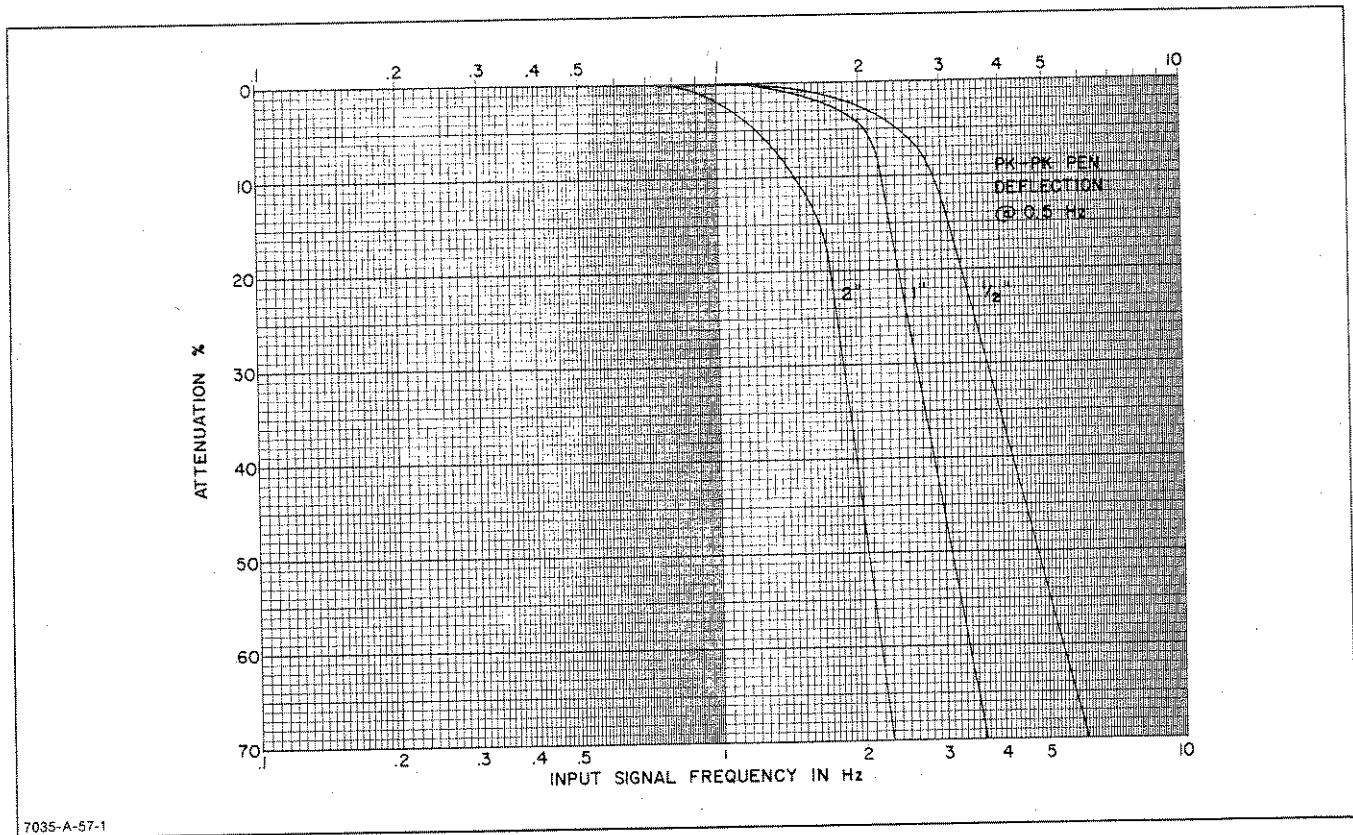

7035-A-57-1

Figure 1-8. Typical Dynamic Response

## SECTION II

### INSPECTION AND INSTALLATION

#### 2-1. INTRODUCTION

2-2. This section provides information for incoming inspection, installation, storage, and shipping.

#### 2-3. INCOMING INSPECTION

#### 2-4. MECHANICAL CHECKS

2-5. Inspect the recorder for mechanical damage, scratches, dents, or other defects.

#### 2-6. ELECTRICAL CHECKS

2-7. The electrical performance of the recorder should be verified upon receipt. Performance checks, suitable for incoming inspection, are presented in Section V.

#### 2-8. DAMAGE CLAIMS

2-9. If the recorder is damaged in transit, or fails to meet specifications upon receipt, notify the carrier and the nearest Hewlett-Packard office immediately. Retain the shipping carton and padding material for the carrier's inspection. The field office will arrange for replacement or repair of your recorder without waiting for claim settlement against the carrier.

#### 2-10. STORAGE

2-11. If the recorder is to be stored for a period of time, the disposable pen should be removed and the upper part of the carriage arm and pen carriage tied to the side of the recorder to prevent damage during handling. Seal the recorder in a moisture proof covering and repackage in a container similar to the original factory carton.

#### 2-12. SHIPPING

2-13. Before returning the recorder for any reason, notify the local field sales office of the difficulty encountered giving the model and serial number of the recorder. They will furnish shipping instructions. The following precautions should be taken when repackaging the recorder:

- a. Remove disposable ink pen. Tape a piece of heavy recording paper to the platen surface.

- b. Secure upper end of carriage arm and pen carriage to side of recorder to prevent movement while in transit with shipping clamp and pad assembly. Place a plastic washer (P/N 2190-0311) between the bracket and platen.

- c. If recorder is being returned for repair, do not send power cord or accessory kit.

- d. Wrap recorder in heavy paper or plastic and surround with three to four inches of shock absorbing material to cushion and prevent movement inside shipping container. The container should be sufficiently durable to prevent damage to recorder during handling. If in doubt, request a shipping carton from nearest Hewlett-Packard Sales Office.

#### 2-14. RECORDER INSTALLATION

2-15. This recorder requires no physical installation for table top operation. The rack mounting brackets (Option 908), can be used to install the 7035B in a standard 19-inch rack console. To install, refer to Figure 2-1.

#### 2-16. OPERATING POWER

2-17. The line power supplied to the recorder must be either 115 or 230 volts ac  $\pm 10\%$ , 48 to 55 Hz, single phase. The voltage selector switch on the recorder rear panel must be set to correspond to the available supply voltage. A 750 mA fuse is used for 115 Vac operation and a 375 mA fuse is required for 230 Vac operation.

#### 2-18. POWER CORD CONFIGURATION

2-19. The type of power cable set shipped with each recorder depends upon the country of destination. Refer to Figure 2-3, Power Cord Configurations for the part and option numbers of the power cable set configurations available.

#### 2-20. GROUNDING

2-21. For optimum performance, the third prong of the ac power cord must be grounded. When operating from ungrounded power sources, adequate grounding is mandatory.

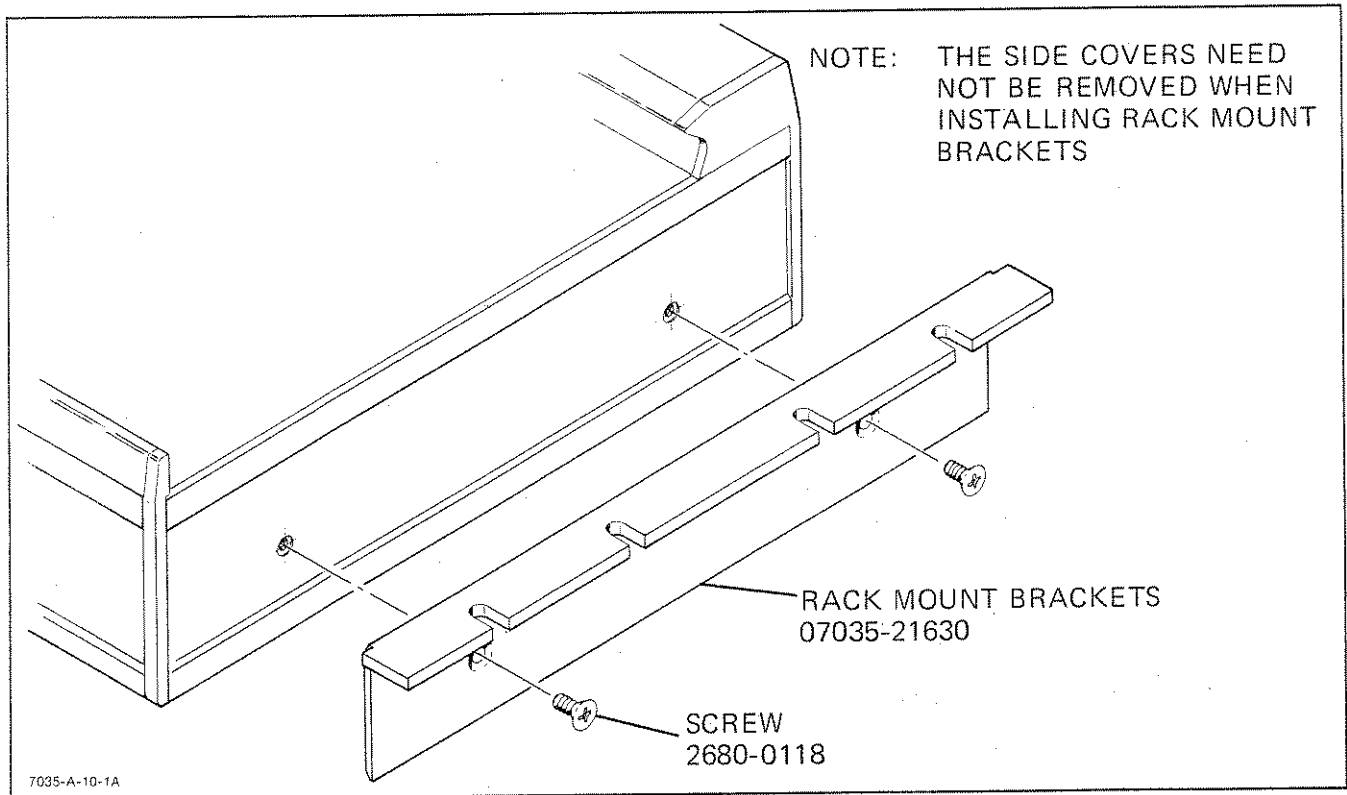

Figure 2-1. Rack Mount Bracket (Option 908) Installation

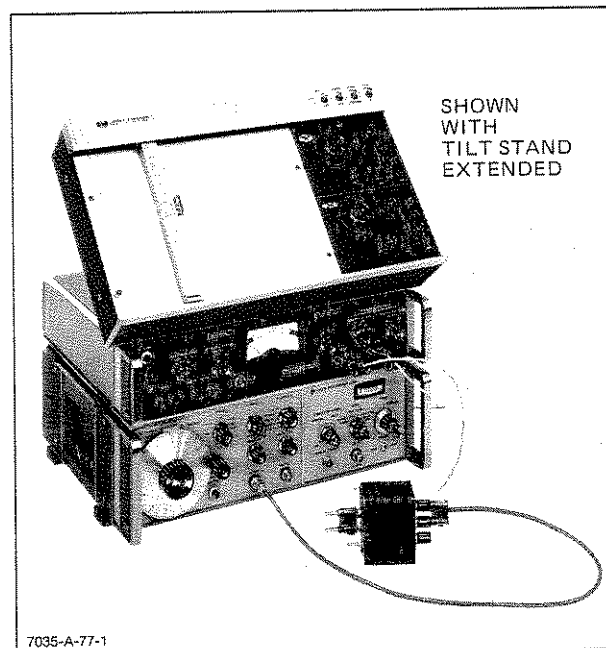

Figure 2-2. Stacked Configuration

**2-22. STACKING H-P INSTRUMENTS**

2-23. The 7035B is equipped with special feet which allow it to be stacked on other H-P instruments. Figure 2-2 shows the 7035B stacked on a 7560A and a 3300A. The rear tilt stand provides easy viewing of the chart.

**2-24. COOLING**

2-25. Cooling is provided by convection. The location or mounting of the recorder must ensure adequate air circulation.

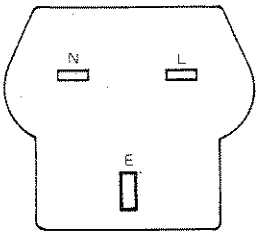
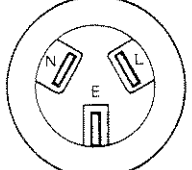
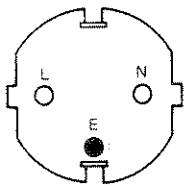
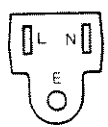
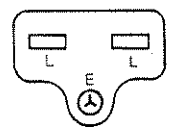
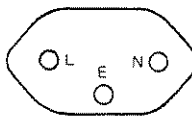
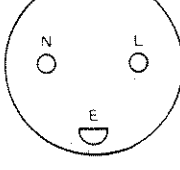
		Option No.
<p>BS 1363A</p> 	<p>HP Part Number 8120-1351; 250 V, 13 A, 1 <math>\phi</math> plug rating. For use in United Kingdom, Cyprus, Nigeria, Zimbabwe, Singapore.</p>	900
<p>AS C112</p> 	<p>HP Part Number 8120-1369; 250 V, 10 A, 1 <math>\phi</math> plug rating. For use in Australia, New Zealand.</p>	901
<p>CEE 7-VII</p> 	<p>HP Part Number 8120-1689; 250 V, 10/16 A, 1 <math>\phi</math> plug rating. For use in East and West Europe, Saudi Arabia, Egypt, South Africa, India.</p>	902
<p>NEMA 5-15P</p> 	<p>HP Part Number 8120-1378; 125 V, 15 A, 1 <math>\phi</math> plug rating. For use in Canada, Japan, Mexico, Philippines, Taiwan, UL approved in United States.</p>	903
<p>NEMA 6-15P</p> 	<p>HP Part Number 8120-0698; 250 V, 15 A, 1 <math>\phi</math> plug rating. For use in Canada, UL approved in United States.</p>	904
<p>SEV 1011</p> 	<p>HP Part Number 8120-2104; 250 V, 10 A, 1 <math>\phi</math> plug rating. For use in Switzerland.</p>	906
<p>DHCK-107</p> 	<p>HP Part Number 8120-2956; 250 V, 10 A, 1 <math>\phi</math> plug rating. For use in Denmark.</p>	912

NOTE: All plugs are viewed from connector end.

L = Line or Active Conductor (also called "live" or "hot")  
 N = Neutral or Identified Conductor  
 E = Earth or Safety Ground

1-A-18-4

Figure 2-3. Power Cord Configurations

## SECTION III

# OPERATING INSTRUCTIONS

### 3-1. OPERATING REQUIREMENTS

#### 3-2. GENERAL

3-3. The basic function of the Model 7035B Recorder is to produce graphic tracings showing the relationship between two variable functions. Slowly varying dc signals representing these functions are applied to the input terminals of the respective axes of the recorder, and its controls adjusted so that the resulting graph will cover the desired scope of operation.

**CAUTION**

Before attempting to operate this recorder the user should study the following paragraphs.

#### 3-4. CONTROLS, CONNECTORS, AND INDICATORS

3-5. The front and rear panel controls, connectors, and indicators are depicted and explained in Figures 3-1 and 3-2.

### 3-6. ELECTRICAL REQUIREMENTS

#### 3-7. INPUT SIGNALS

3-8. The recorder input terminals (+ and -) must be supplied with a dc signal on each axis. This signal should be in direct proportion to the actual function unless a special relationship is required, such as the logarithmic value of the input voltage. These signals must vary at a rate within the response capabilities of the recorder and have amplitudes within its scale ranges. If an excessive amount of ac noise is present in the input signals, the response of the recorder may become sluggish and erratic or oscillatory.

**CAUTION**

Do not directly apply signals in excess of 250 volts on the X-axis or 175 volts on the Y-axis.

#### 3-9. RECORDING INPUT CONNECTIONS

3-10. Input terminals for each axis are located on the front panel adjacent to the corresponding range

switches. Front panel terminals will accept either "banana" plugs or open wires.

#### 3-11. CONNECTION TECHNIQUES FOR THE GUARD SHIELD

3-12. Connect the recorder's guard shield in one of the following ways:

- a. To the SOURCE ground when:
  1. Operating on low level ranges.
  2. When ac noise pickup is a problem.
- b. To the negative input using the convenient shorting straps when conditions 1 and 2 do not exist.

**CAUTION**

Do not leave the guard shield disconnected or floating. Tighten guard strap securely.

#### 3-13. MAXIMUM ALLOWABLE SOURCE IMPEDANCE

3-14. No restrictions except on fixed 1 mV/in. (0.4 mV/cm). Up to 20 k ohm source impedance will not appreciably alter the recorder's performance. Higher source impedance will cause an increase in dead zone and a decrease in pen speed. Values up to approximately 100 k may be compensated for by adjusting the servo amplifier gain adjustment on the front panel.

### 3-15. OPERATING PRECAUTIONS

3-16. The LINE toggle switch applies the 115 or 230 volts ac to the recorder. To lower power dissipation and avoid unnecessary wear to the balancing potentiometers and other mechanical parts when not actually recording, place the servo toggle switch to the OFF position.

3-17. When a voltage in excess of the RANGE SETTING is applied to either set of input terminals, the carriage arm or pen mount (depending upon the axis used) will be driven rapidly to full scale and strike the stop. If this condition prevails, the motor will continue running due to a slip-clutch arrangement. Prolonged running against the stop may cause excessive motor heating and clutch wear.

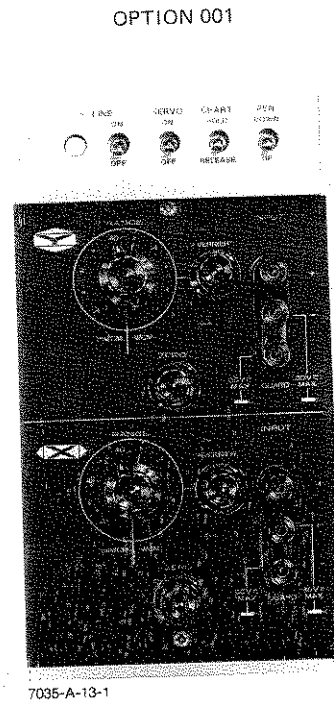
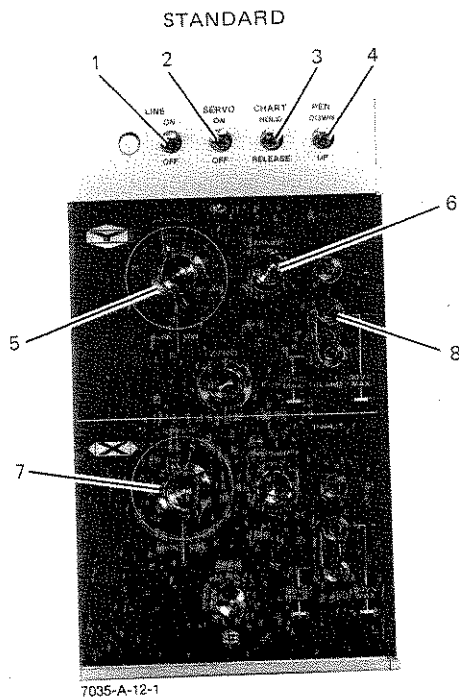

1. **LINE SWITCH.** A two-position toggle switch, at the upper left of the control panel, controls the recorder power in the following positions:
  - a. **OFF.** Power to the recorder is shut off.
  - b. **ON.** All the circuits in the recorder are operable except for the servo system. This position may be used as Standby.
2. **SERVO SWITCH.** Activates the recorder's servo system.
3. **CHART SWITCH.** The Chart Switch **HOLD** position energizes the electrostatic paper holddown, and the **RELEASE** position de-energizes it.
4. **PEN SWITCH.** The Model 7035B is equipped with an electric pen lift that is controlled by a two-position toggle switch located in the upper right section of the control panel.
5. **RANGE SELECTOR.** The range selectors are located in the center portion of the control panel, one for each axis. The selector has 5 calibrated positions and 5 uncalibrated positions. Each uncalibrated position is indicated by a small circle. The sensitivity of the uncalibrated position is controlled by the vernier control and can be adjusted to cover the span between the adjacent calibrated ranges.

**CAUTION**

Voltage applied between the input terminals should never exceed 175 volts on the Y-axis or 250 volts on the X-axis. No input terminal

should be placed more than 30 Vac or dc above the chassis potential.

6. **RANGE SELECTOR VERNIER.** The range verniers are located to the immediate right of the range selectors. The vernier is a multi-turn, high resolution potentiometer assembly which adjusts the sensitivity of the recorder when the range selector is in an uncalibrated position.
7. **ZERO CONTROL.** The zero controls are located directly below the range selectors on the control panel. The zero control is a multi-turn, high resolution potentiometer assembly which controls the zero position of the pen.

**CAUTION**

To prevent strain on the servo drives, the zero scale offset should be employed only to counteract a steady-state input which drives the pen toward full scale, or to reposition the minimum point at scale zero. It should not be used to establish the minimum point effectively off the paper, as this will cause the servo drives to exert continuous force against the stop mechanisms and cause excessive clutch wear.

8. **INPUT TERMINALS.** Three input terminals for each axis are located on the right-hand edge of the control panel. Two terminals are polarized and the third is a guard input terminal. Flexible operation is afforded by use of a removable shorting strap between the negative input terminal and the guard. The terminals accept either open wire or banana plug connectors.

Figure 3-1. Front Panel Controls (7035B Standard and Option 001 Models)

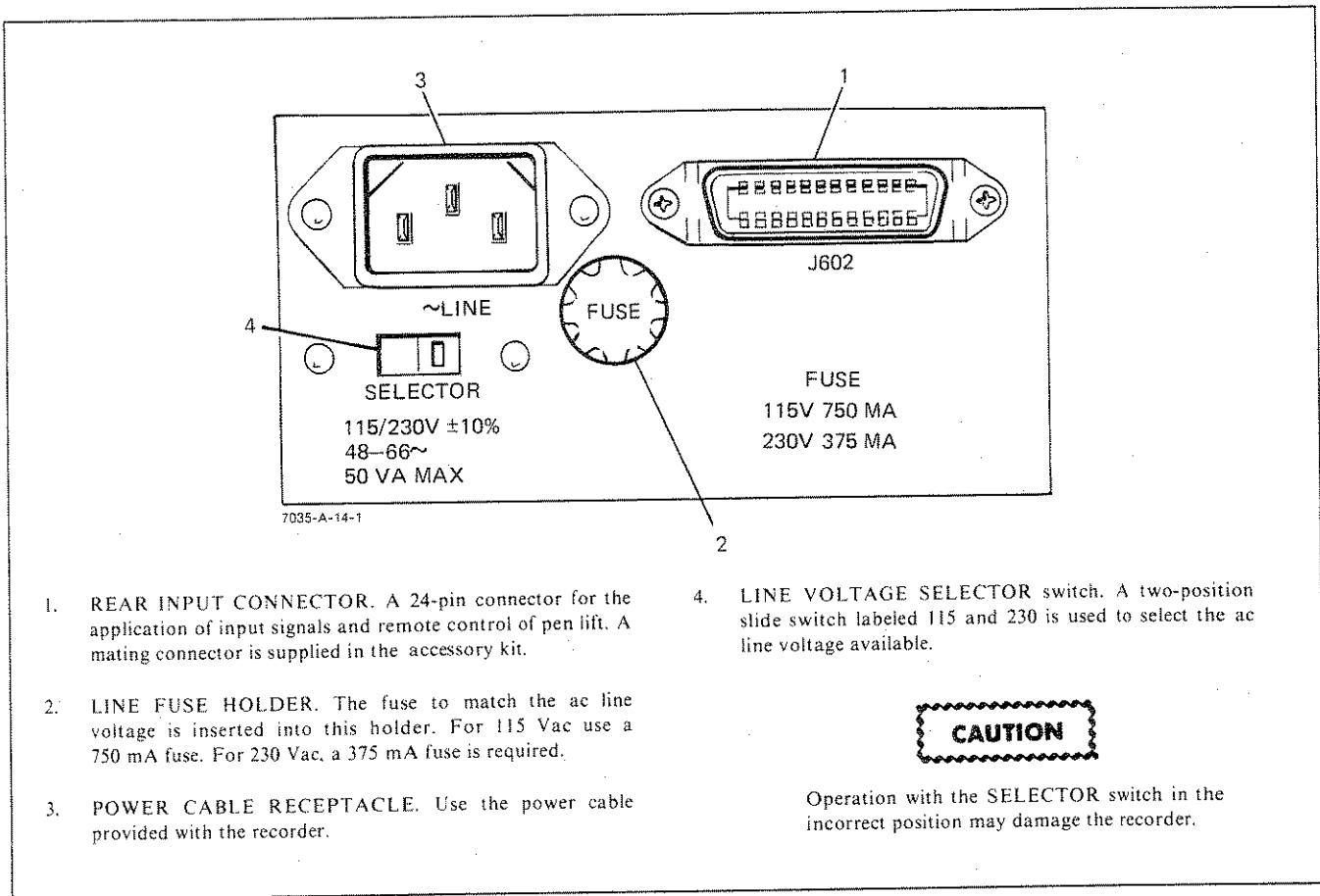

1. REAR INPUT CONNECTOR. A 24-pin connector for the application of input signals and remote control of pen lift. A mating connector is supplied in the accessory kit.
2. LINE FUSE HOLDER. The fuse to match the ac line voltage is inserted into this holder. For 115 Vac use a 750 mA fuse. For 230 Vac, a 375 mA fuse is required.
3. POWER CABLE RECEPTACLE. Use the power cable provided with the recorder.

4. LINE VOLTAGE SELECTOR switch. A two-position slide switch labeled 115 and 230 is used to select the ac line voltage available.

**CAUTION**

Operation with the SELECTOR switch in the incorrect position may damage the recorder.

Figure 3-2. Rear Panel

3-18. Operation on the most sensitive input range with no input (input terminals not connected) will result in an inaccurate zero null. This can be overcome by shunting the input terminals with a 20 kilohm (maximum resistor).

### 3-19. OPERATING INSTRUCTIONS

#### 3-20. OPERATIONAL CONDITIONS

3-21. The amplitude of the input signals must be within the scale range and vary in level within the response capabilities of the recorder.

#### 3-22. CONNECT INPUTS

3-23. Connect the signal inputs to each axis through the front input terminals using open wires or banana connectors, or through the rear input connectors using the mating connector furnished. Connect the guard input terminal to the negative input terminal. However, if the shields are to be driven directly from a remote common mode source, the jumper is disconnected and a separate wire is connected between the guard input and the common mode voltage source. Set RANGE switch to the expected maximum values.

#### 3-24. ENERGIZE RECORDER

3-25. Set the LINE toggle switch to ON.

**CAUTION**

Units using photochoppers require a few minutes of operation to eliminate dark storage effects. After prolonged storage of 3 to 6 months, a longer period of run in may be required. After several days of storage, a slight improvement in retrace characteristics may be produced by several high speed full scale excursions on each axis.

#### 3-26. INSTALL PAPER

3-27. Install a sheet of graph paper on the recording platen, aligning lower and left edges with corresponding paper guides. Set the CHART switch to HOLD, thereby activating the Electrostatic paper holddown system. Smooth paper as necessary.

## Section III

## 3-28. INSTALL PEN

3-29. Push the disposable pen into the notched holder located on the scale, and turn clockwise to lock in holder. See Figure 3-3.

**CAUTION**

The disposable pen incorporates a precision writing tip. Care must be taken not to damage this tip during pen changing or other handling. Writing by hand on any surface may damage pen tip. Use pen only in pen holder on recorder.

## 3-30. ZERO SET

3-31. Connect the input signals to the recorder and adjust ZERO controls so that the resulting graph will cover the desired area on the paper.

## 3-32. LOWER PEN

3-33. Place PEN toggle switch to DOWN position.

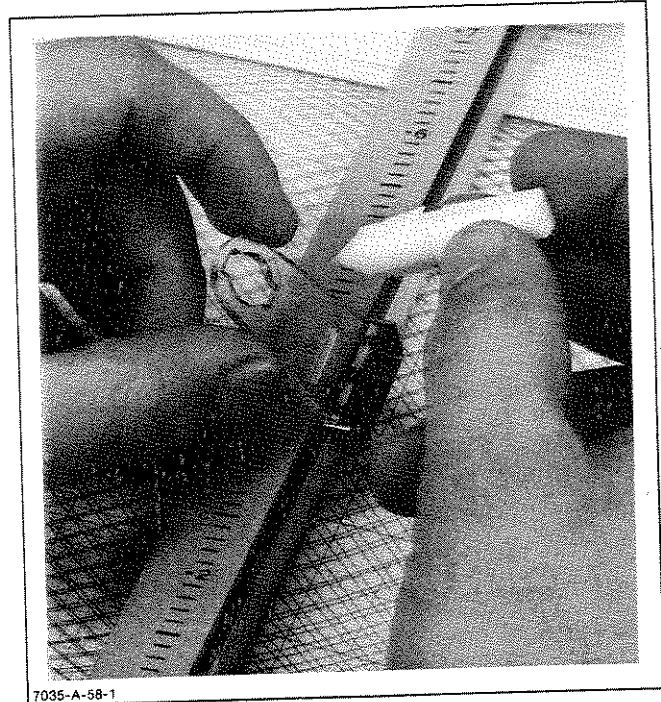

7035-A-58-1

Figure 3-3. Disposable Pen Installation



